

VerSus International Student Competition

1

Poster 1: Analysis and Concepts

Identificative alphanumeric string code: _8a45an3f_

BAHAY KAWAYAN A Post-disaster House for the Philippines



The proposal is a transitional house for the communities of Roxas in the Philippines affected by the Typhoon Haiyan in November 2013.

TRADITION



The proposal is a low cost house - based on the traditional Filipino house, the Bahay Kubo- designed following four dimensions: Environmental, Natural Hazards, Socio-Cultural and Socio-Economic.

INNOVATION



A prototype of the house has been built in July this year, to test its structural performance and feasibility of construction. Approx. cost: 1,000 USD.



ENVIRONMENTAL

Available Materials

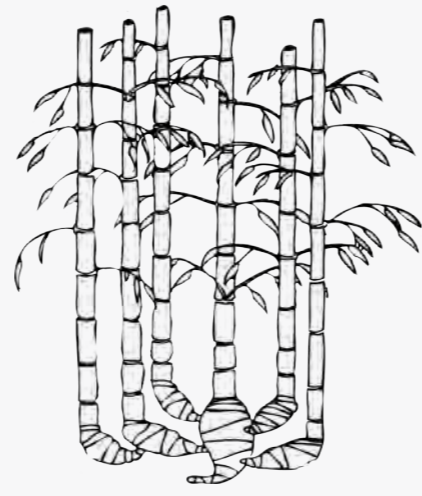

Round bamboo: Fast growing, already available without complex processes and machinery in the area, contributing to reduce transportation costs and pollution.

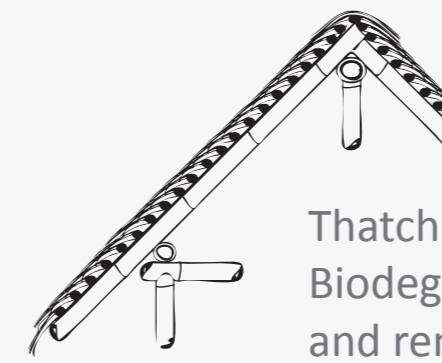

Thatch roof: Biodegradable and renewable, it is an insulating waterproof layer.

Comfort

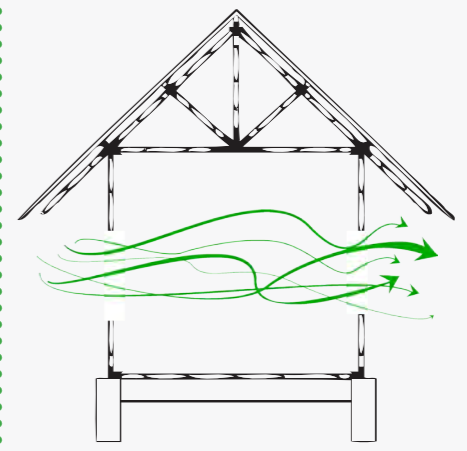

Natural ventilation: Crossed ventilation to reduce the humidity of the house and the material. Natural shading: Long eaves to protect bamboo from the rain and direct sunlight.

NATURAL HAZARDS

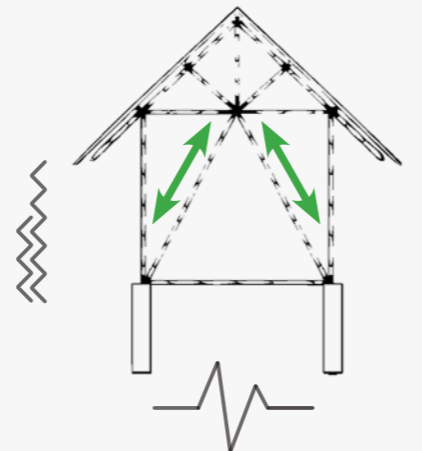

Earthquakes: Flexibility of bamboo for coping with earthquakes. Connections and bracing to foundations.

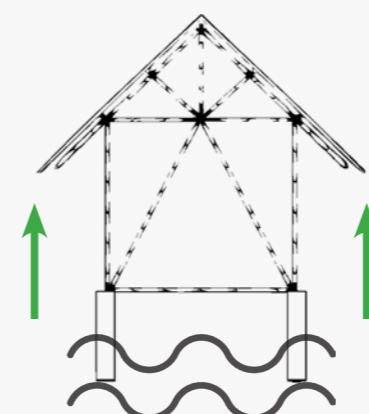

Floods: Traditional houses are elevated from the ground for rainy seasons.

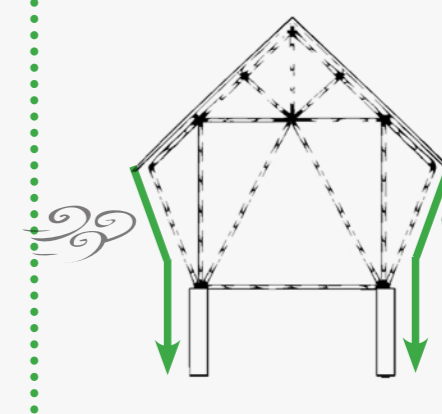

Typhoons and strong winds: Hip roof and over-hang with bracings to resist uplifts.

SOCIO-CULTURAL

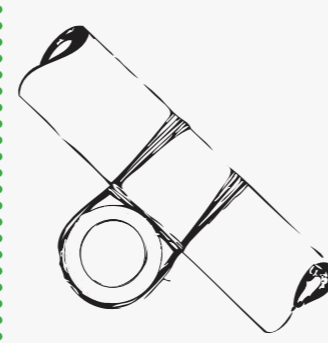

Lashing: bamboos together with rattan, rope or fishing line instead of nailing them, to prevent splitting.

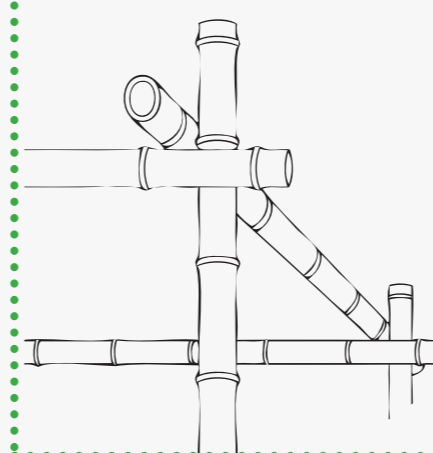

3D connections: bracing is used to reduce the momentum, and in three dimensions, defining the geometry of the design. the bamboo culm won't be crushed and damaged in the weak sides of the bamboo culm.

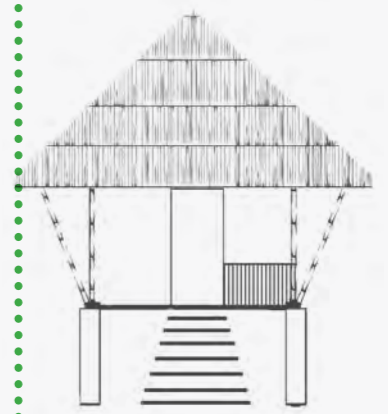

Buffer: Use of shaded intermediate spaces between public and private spaces.

SOCIO-ECONOMIC

Available Materials

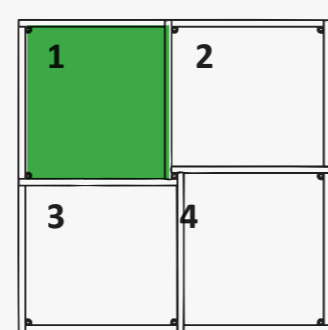

Minimum module: A cube of 8'x8' (2,44mt.x2,44mt.) based on the bamboo mats. It can be repeated for different house sizes: 12m2 expandable to 24m2, or 18m2 expandable to 36m2.

Flexibility: Doors and windows

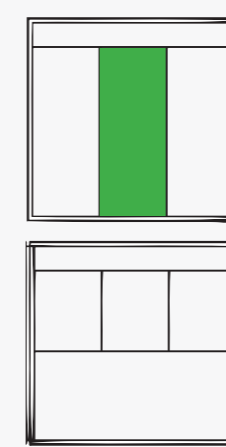

Structure based in frames: allows doors and windows in different positions. Openings can be placed following the orientation of the house, and specific conditions.

Adaptability: Progressive house

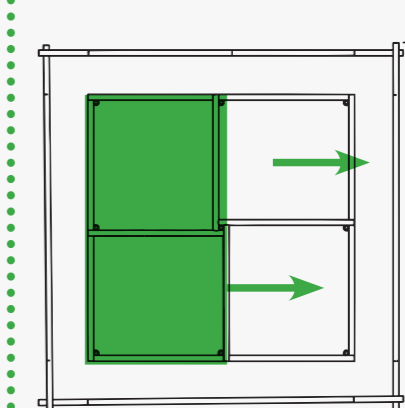

The house can be expanded by the family without compromising the structure. A roof under which the families can decide to expand or to keep it as porch or terrace.